

M54566P/FP

7-UNIT 400mA DARLINGTON TRANSISTOR ARRAY

DESCRIPTION

M54566P and M54566FP are seven-circuit collector-current-synchronized Darlington transistor arrays. The circuits are made of PNP and NPN transistors. Both the semiconductor integrated circuits perform high-current driving with extremely low input-current supply.

FEATURES

- High breakdown voltage ($BV_{CEO} \geq 50V$)
- High-current driving ($I_{c(max)} = 400mA$)
- Active L-level input
- Wide operating temperature range ($T_a = -20$ to $+75^\circ C$)

APPLICATION

Interfaces between microcomputers and high-voltage, high-current drive systems, drives of relays and printers, and MOS-bipolar logic IC interfaces

FUNCTION

The M54566 is produced by adding PNP transistors to M54222 inputs. Seven circuits having active L-level inputs are provided.

Resistance of $8k\Omega$ is provided between each input and PNP transistor base. The input emitters are connected to V_{cc} pin (pin 9). Output transistor emitters are all connected to the GND pin (pin 8).

Collector current is 400mA maximum. Collector-emitter supply voltage is 50V maximum.

These ICs are optimal for drivers that are driven with N-MOS IC output and absorb collector current.

The M54566FP is enclosed in a molded small flat package, enabling space-saving design.

PIN CONFIGURATION

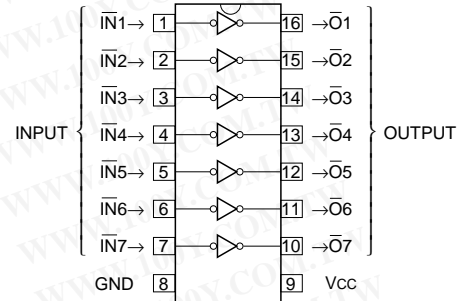

Package type 16P4(P)
16P2N-A(FP)

CIRCUIT DIAGRAM

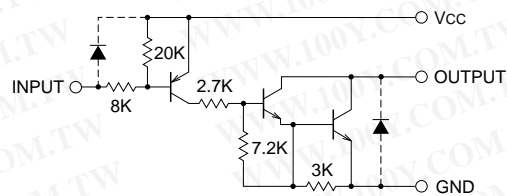

The seven circuits share the V_{cc} and GND.
The diode, indicated with the dotted line, is parasitic, and cannot be used.

Unit : Ω

勝特力材料 886-3-5753170
 勝特力电子(上海) 86-21-54151736
 勝特力电子(深圳) 86-755-83298787
[Http://www.100y.com.tw](http://www.100y.com.tw)

ABSOLUTE MAXIMUM RATINGS (Unless otherwise noted, $T_a = -20 \sim +75^\circ C$)

Symbol	Parameter	Conditions	Ratings	Unit
V_{cc}	Supply voltage		10	V
V_{CEO}	Collector-emitter voltage	Output, H	$-0.5 \sim +50$	V
I_C	Collector current	Current per circuit output, L	400	mA
V_i	Input voltage		$-0.5 \sim V_{cc}$	V
P_d	Power dissipation	$T_a = 25^\circ C$, when mounted on board	1.47(P)/1.00(FP)	W
T_{opr}	Operating temperature		$-20 \sim +75$	$^\circ C$
T_{stg}	Storage temperature		$-55 \sim +125$	$^\circ C$

M54566P/FP

7-UNIT 400mA DARLINGTON TRANSISTOR ARRAY

RECOMMENDED OPERATING CONDITIONS (Unless otherwise noted, Ta = -20 ~ +75°C)

Symbol	Parameter	Limits			Unit	
		min	typ	max		
Vcc	Supply voltage	4	5	8	V	
Vo	Output voltage	0	—	50	V	
Ic	Collector current (Current per 1 circuit when 7 circuits are coming on simultaneously)	Vcc = 5V, Duty Cycle P : no more than 10% FP : no more than 6%	0	—	350	mA
		Vcc = 5V, Duty Cycle P : no more than 30% FP : no more than 20%	0	—	200	
VIH	"H" input voltage	Vcc-0.2	—	Vcc	V	
VIL	"L" input voltage	0	—	Vcc-3	V	

ELECTRICAL CHARACTERISTICS (Unless otherwise noted, Ta = -20 ~ +75°C)

Symbol	Parameter	Test conditions	Limits			Unit
			min	typ*	max	
V (BR) CEO	Collector-emitter breakdown voltage	ICEO = 100μA	50	—	—	V
VCE (sat)	Collector-emitter saturation voltage	VI = Vcc-3V, Ic = 350mA	—	1.1	2.2	V
		VI = Vcc-3V, Ic = 200mA	—	0.9	1.6	
Ii	Input current	VI = Vcc-3.5V	—	-0.38	-0.58	mA
ICC	Supply current (one circuit coming on)	Vcc = 5V, VI = Vcc-3.5V	—	1.4	3.0	mA
hFE	DC amplification factor	VCE = 4V, Vcc = 5V, Ic = 350mA, Ta = 25°C	2000	10000	—	—

* : The typical values are those measured under ambient temperature (Ta) of 25°C. There is no guarantee that these values are obtained under any conditions.

SWITCHING CHARACTERISTICS (Unless otherwise noted, Ta = 25°C)

Symbol	Parameter	Test conditions	Limits			Unit
			min	typ	max	
ton	Turn-on time	CL = 15pF (note 1)	—	95	—	ns
toff	Turn-off time		—	2500	—	ns

NOTE 1 TEST CIRCUIT

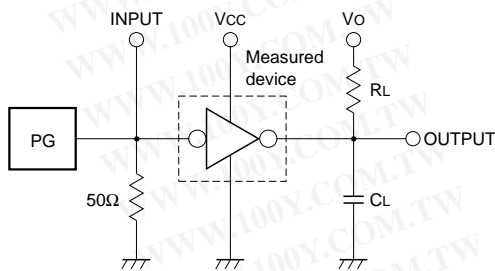

- (1) Pulse generator (PG) characteristics : PRR = 1kHz, tw = 10μs, tr = 6ns, tf = 6ns, Zo = 50Ω, VI = 1 to 4V
- (2) Input-output conditions : RL = 30Ω, Vo = 10V, Vcc = 4V
- (3) Electrostatic capacity CL includes floating capacitance at connections and input capacitance at probes

TIMING DIAGRAM

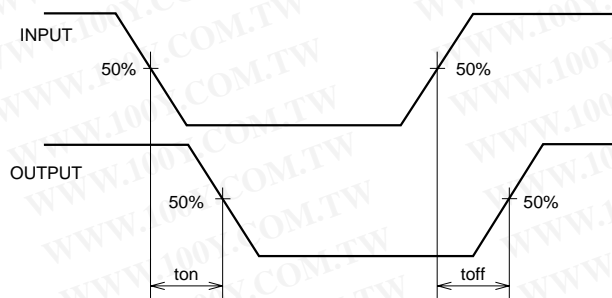

勝特力材料 886-3-5753170
 勝特力电子(上海) 86-21-54151736
 勝特力电子(深圳) 86-755-83298787
[Http://www.100y.com.tw](http://www.100y.com.tw)

TYPICAL CHARACTERISTICS

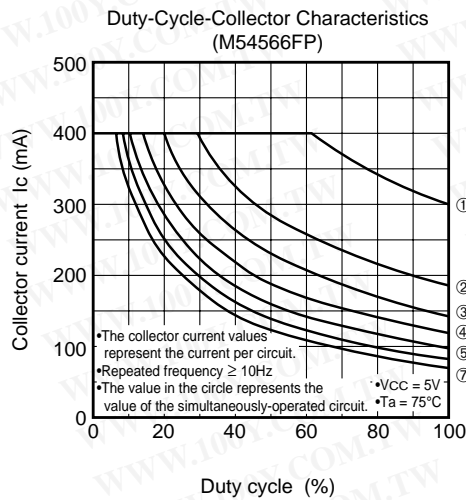
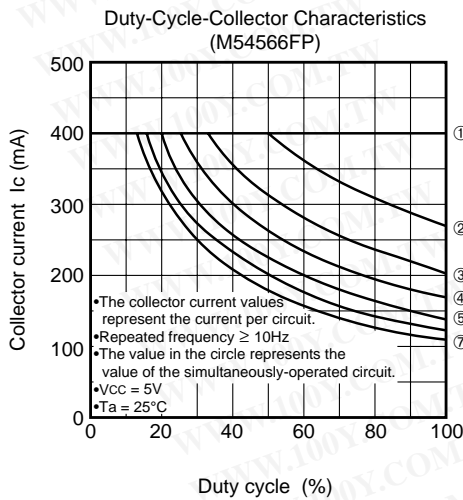
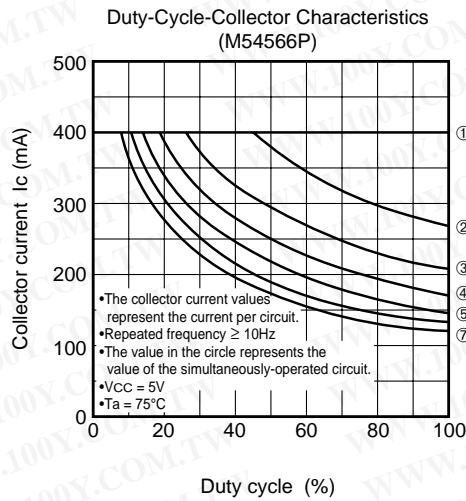
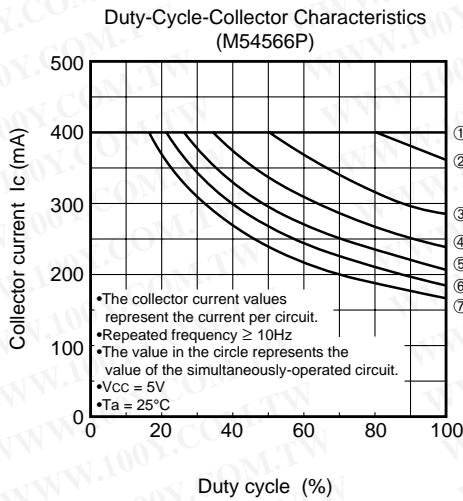
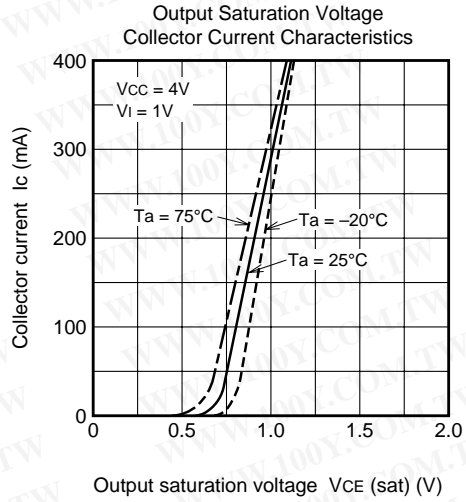
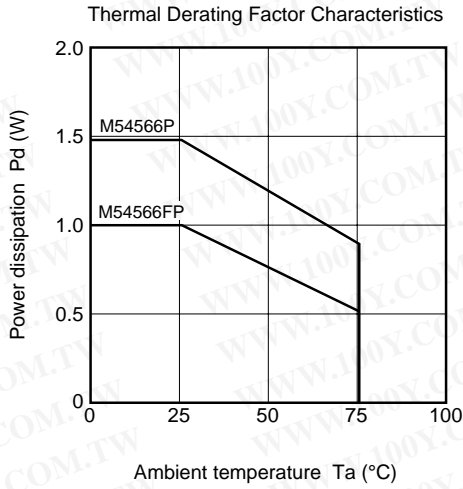

M54566P/FP

7-UNIT 400mA DARLINGTON TRANSISTOR ARRAY

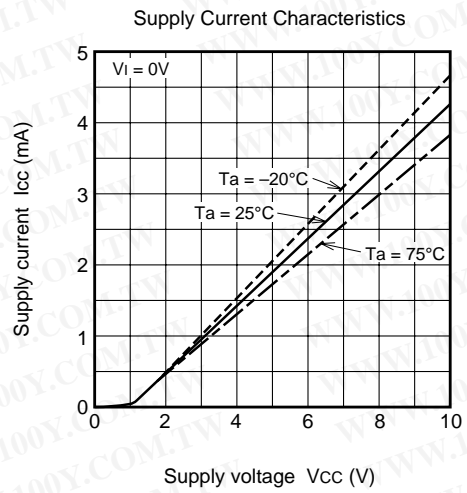
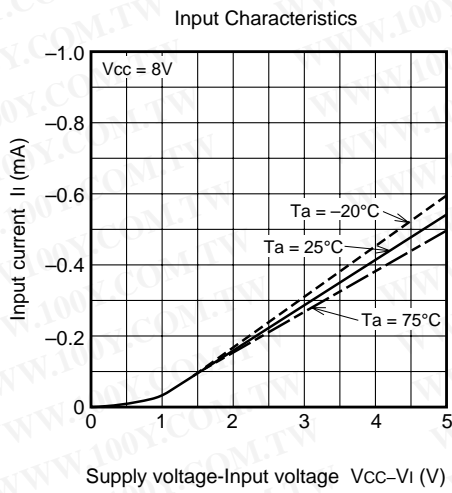
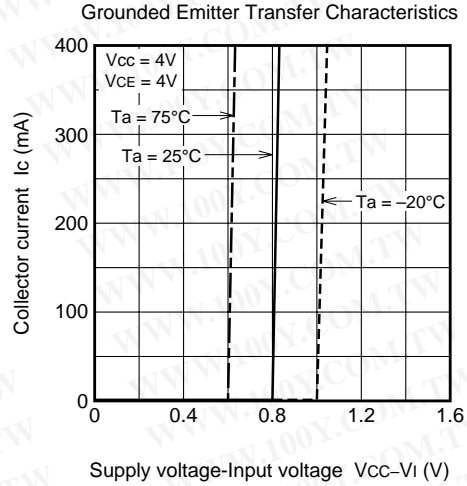
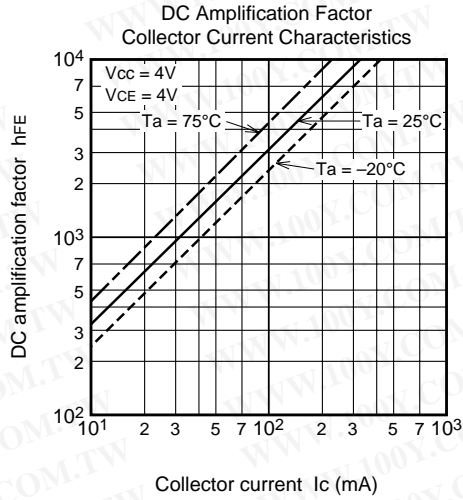

勝特力材料 886-3-5753170
 勝特力电子(上海) 86-21-54151736
 勝特力电子(深圳) 86-755-83298787
[Http://www.100y.com.tw](http://www.100y.com.tw)